

# COLLAPSIBLE PLATFORM TRUCK

## Features

Designed to be carried ergonomically by the handle while in the stowed position



Measures only 29" long when folded to stow easily into the smallest vehicle

P/N  
MTA2-L

- Uses include transporting beverages, food, and general merchandise from stockroom to store floor
- Collapses and folds within seconds to easily be carried to and stowed in any size vehicle
- Configures to 8 different positions
- Non-marking casters are made of durable thermoplastic rubber for high rolling efficiency to reduce user strain
- Made of lightweight, high-strength aluminum for optimum strength-to-weight ratio
- Two of the four swivel casters include directional locks to assist with moving the load in a straight direction



# COLLAPSIBLE PLATFORM TRUCK

## 1 Truck - 8 Possible Positions

### 2 DOLLY POSITIONS

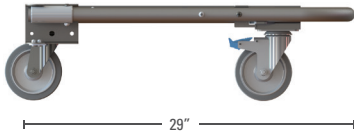

### 6 PLATFORM TRUCK POSITIONS

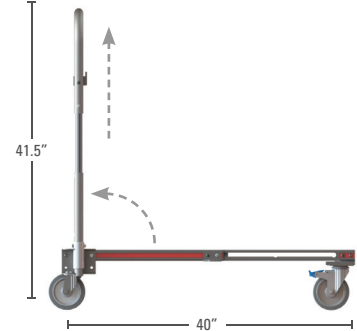
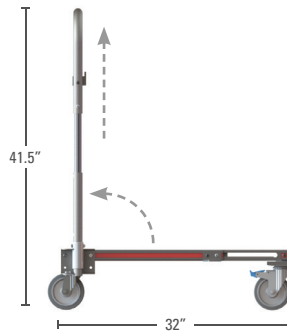
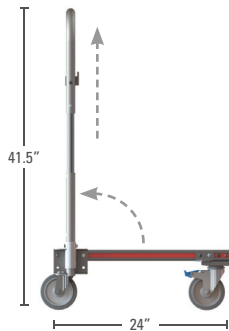
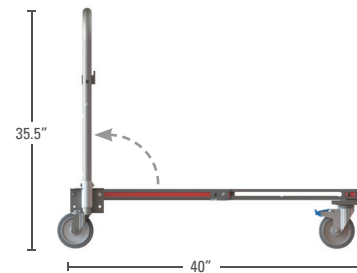
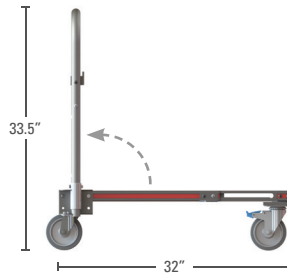
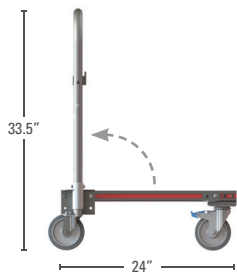

### As easy as 1... 2... 3



### SPECIFICATIONS

	MTA2-L
<b>STOWED POSITION</b>	
Overall height	29"
Overall depth	8-1/2"
Overall width	16"
<b>CART POSITION</b>	
Overall height, handle extended	41-1/2"
Overall width	16"
Overall depth, collapsed position	24"
Overall depth, middle position	32"
Overall depth, expanded position	40"
Capacity	650 lbs.
Casters	(2) - 5" x 1-1/4" swivel; (2) - 5" x 1-1/4" swivel with direction lock capability
Weight	33 lbs.

**MAGLINER**<sup>®</sup>  
magliner.com

Magline, Inc.  
1205 West Cedar Street | Standish, MI 48658  
1.800.MAGLINE (624.5463)  
(989) 512.1000 (Outside U.S. & Canada)  
Fax: (989) 803.5941